



# SIMEX

SOLUCIONES HIDRAULICAS INTEGRALES



## Lista de Precios Enero 2017



**SHI de México S. de R.L. de C.V.**

## **INDICE**

<b>VALVULAS.....</b>	<b>1</b>
<b>CODOS Y TAPAS CIEGAS.....</b>	<b>1</b>
<b>TEES, CRUCES Y REDUCCIONES.....</b>	<b>2</b>
<b>EXTREMIDADES Y CARRETES.....</b>	<b>3</b>
<b>TORNILLOS.....</b>	<b>3</b>
<b>JUNTAS GIBAULT, ABRAZADERAS, EMPAQUES, BRIDAS Y CONTRAMARCOS.....</b>	<b>4</b>
<b>ALCANTARILLADO.....</b>	<b>5</b>
<b>VALVULAS DE MARIPOSA MARCA SIMEX .....</b>	<b>6</b>
<b>VALVULAS DE MARIPOSA MARCA BRAY.....</b>	<b>6</b>
<b>VALVULAS ELIMINADORAS DE AIRE, DE ADMISION Y EXPULSION DE AIRE, VALVULAS AUTOMATICAS .....</b>	<b>7</b>
<b>ADAPTADOR BRIDADO UNIVERSAL, COPLE UNIVERSAL DE RANGO AMPLIO, ALCANTARILLADO POLIETILENO.....</b>	<b>8</b>
<b>ABRAZADERAS DE REPARACION DE ACERO INOXIDABLE, COLPE DE DESMONTAJE, JUNTAS TIPO DRESER, TUBERIA DE ACERO GALVANIZADO.....</b>	<b>9</b>

### VALVULAS

DIAMETRO		VASTAGO FIJO				VASTAGO SALIENTE RESILENTE	CHECK RESILENTE	CHECK BRONCE
pulg.	mm.	BRONCE	FLEXIBLE BRIDADA	FLEX C/VOL BRIDADA	FLEXIBLE ESPIGAS			
2	51	\$ 4,438	\$ 3,031	\$ 3,150	\$ 2,560	\$ 3,676	\$ 3,338	
2 1/2	64	\$ 4,665	\$ 3,534	\$ 3,653	\$ 3,001	\$ 4,286	\$ 3,477	
3	76	\$ 6,473	\$ 4,176	\$ 4,318	\$ 3,762	\$ 5,774	\$ 4,159	
4	102	\$ 8,852	\$ 5,136	\$ 5,352	\$ 4,872	\$ 7,887	\$ 5,883	
6	152	\$ 13,417	\$ 8,344	\$ 8,668	\$ 8,562	\$ 13,616	\$ 11,092	
8	203	\$ 23,359	\$ 14,364	\$ 14,758	\$ 14,705	\$ 22,128	\$ 20,304	
10	254	\$ 34,171	\$ 21,553	\$ 22,160		\$ 35,544	\$ 31,751	
12	305	\$ 47,771	\$ 33,753	\$ 34,732		\$ 50,050	\$ 47,827	
14	356		\$ 65,477	\$ 65,477			\$ 77,041	
16	406		\$ 84,373	\$ 84,373			\$ 140,229	
18	457		\$ 128,718	\$ 128,718				\$ 201,577
20	508		\$ 174,004	\$ 174,004				\$ 262,228
24	610		\$ 266,846	\$ 266,846				\$ 407,380
30	762		\$ 546,337	\$ 546,337				
36	914		\$ 841,922	\$ 841,922				

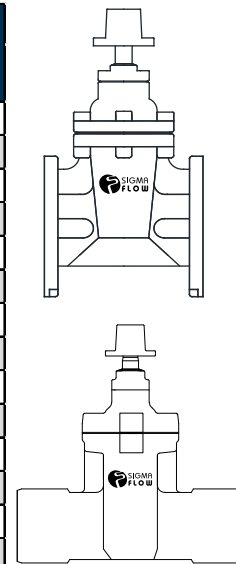

### CONEXIONES BRIDADAS

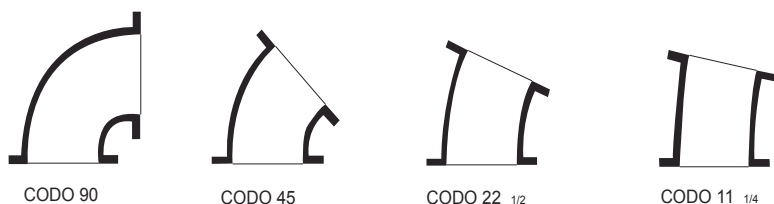

### CODOS

DIMENSION	GRADOS			
	90°	45°	22 1/2°	11 1/2°
2	\$ 567	\$ 495	\$ 539	\$ 570
2 1/2	\$ 918	\$ 882	\$ 882	\$ 882
3	\$ 1,152	\$ 921	\$ 886	\$ 886
4	\$ 1,984	\$ 1,763	\$ 1,763	\$ 1,578
6	\$ 2,865	\$ 2,424	\$ 2,372	\$ 2,380
8	\$ 4,603	\$ 3,885	\$ 3,976	\$ 3,879
10	\$ 7,493	\$ 5,730	\$ 5,912	\$ 5,398
12	\$ 10,358	\$ 8,816	\$ 8,885	\$ 8,233
14	\$ 15,314	\$ 11,688	\$ 13,385	\$ 13,385
16	\$ 19,639	\$ 14,845	\$ 16,937	\$ 15,699
18	\$ 26,570	\$ 19,956	\$ 19,956	\$ 19,956
20	\$ 32,040	\$ 22,792	\$ 27,591	\$ 27,591
24	\$ 47,691	\$ 33,314	\$ 40,621	\$ 40,900
30	\$ 97,630	\$ 76,522	\$ 77,742	\$ 78,644
36	\$ 145,699	\$ 119,779	\$ 122,485	\$ 123,542
42	Cotizar	Cotizar	Cotizar	Cotizar

### TAPAS CIEGAS

DIMENSION	PRECIO
2	\$ 191
2 1/2	\$ 267
3	\$ 402
4	\$ 683
6	\$ 1,084
8	\$ 1,846
10	\$ 2,760
12	\$ 3,692
14	\$ 5,360
16	\$ 7,322
18	\$ 9,676
20	\$ 10,971
24	\$ 19,422
30	\$ 34,336
36	\$ 64,076
42	Cotizar

### TEE, CRUCES Y REDUCCIONES

DIMENSION	TEE	CRUZ	RED.
2 x 2	\$ 860	\$ 1,384	

2 ½ x 2	\$ 1,454	\$ 1,492	\$ 659
2 ½ x 2 ½	\$ 1,481	\$ 1,720	

3 x 2	\$ 1,513	\$ 2,306	\$ 691
3 x 2 ½		\$ 2,387	\$ 853
3 x 3	\$ 1,843	\$ 2,387	

4 x 2	\$ 2,066	\$ 2,828	\$ 1,102
4 x 2 ½		\$ 2,984	\$ 1,113
4 x 3	\$ 2,304	\$ 2,729	\$ 1,322
4 x 4	\$ 2,865	\$ 3,526	

6 x 2	\$ 3,253	\$ 4,085	\$ 1,411
6 x 2 ½	\$ 3,253	\$ 4,085	\$ 1,440
6 x 3	\$ 3,730	\$ 4,085	\$ 1,701
6 x 4	\$ 4,030	\$ 4,605	\$ 1,984
6 x 6	\$ 4,187	\$ 5,744	

8 x 2	\$ 6,704	\$ 6,365	\$ 2,766
8 x 2 ½	\$ 6,192	\$ 6,456	\$ 2,766
8 x 3	\$ 6,192	\$ 6,745	\$ 2,815
8 x 4	\$ 6,171	\$ 6,745	\$ 2,865
8 x 6	\$ 6,488	\$ 7,273	\$ 3,302
8 x 8	\$ 6,832	\$ 8,958	

10 x 2 ½	\$ 9,414	\$ 9,652	\$ -
10 x 3	\$ 9,205	\$ 10,034	\$ 3,857
10 x 4	\$ 9,601	\$ 10,468	\$ 3,702
10 x 6	\$ 9,920	\$ 10,579	\$ 3,967
10 x 8	\$ 9,838	\$ 12,222	\$ 4,849
10 x 10	\$ 10,271	\$ 14,546	

12 x 3	\$ 11,647	\$ 13,533	\$ 5,526
12 x 4	\$ 13,932	\$ 12,406	\$ 5,148
12 x 6	\$ 12,978	\$ 13,929	\$ 5,730
12 x 8	\$ 13,551	\$ 15,207	\$ 6,391
12 x 10	\$ 14,634	\$ 17,204	\$ 7,141
12 x 12	\$ 16,970	\$ 20,067	

14 x 4	\$ 20,039	\$ 21,221	\$ 8,374
14 x 6	\$ 20,646	\$ 21,970	\$ 8,502
14 x 8	\$ 21,486	\$ 23,427	\$ 9,549
14 x 10	\$ 21,970	\$ 25,253	\$ 10,447
14 x 12	\$ 25,736	\$ 30,581	\$ 11,506
14 x 14	\$ 24,332	\$ 32,459	

16 x 4	\$ 25,253	\$ 26,666	\$ -
16 x 6	\$ 24,320	\$ 26,954	\$ 10,643
16 x 8	\$ 24,843	\$ 30,026	\$ 11,534
16 x 10	\$ 26,501	\$ 30,380	\$ 12,291
16 x 12	\$ 27,196	\$ 37,919	\$ 13,823
16 x 14	\$ 33,507	\$ 40,912	\$ 14,637
16 x 16	\$ 32,641	\$ 41,519	

DIMENSION	TEE	CRUZ	RED.
18 x 6	\$ 29,791	\$ 30,469	\$ 13,113
18 x 8	\$ 29,827	\$ 31,112	\$ 13,235
18 x 10	\$ 29,868	\$ 32,365	\$ 14,568
18 x 12	\$ 29,128	\$ 34,873	\$ 15,429
18 x 14	\$ 34,595	\$ 39,517	\$ 16,213
18 x 16	\$ 38,983	\$ 48,441	\$ 18,700
18 x 18	\$ 40,232	\$ 50,256	

20 x 6	\$ 39,761	\$ 41,095	\$ -
20 x 8	\$ 39,786	\$ 41,178	\$ 17,278
20 x 10	\$ 41,095	\$ 43,766	\$ 18,135
20 x 12	\$ 41,160	\$ 46,437	\$ 20,200
20 x 14	\$ 42,439	\$ 47,732	\$ 20,962
20 x 16	\$ 42,363	\$ 53,609	\$ 20,397
20 x 18	\$ 56,589	\$ 64,487	\$ 24,085
20 x 20	\$ 51,564	\$ 68,891	

24 x 6	\$ 61,975	\$ -	\$ -
24 x 8	\$ 63,284	\$ 64,650	\$ 31,491
24 x 10	\$ 63,337	\$ 67,296	\$ 32,089
24 x 12	\$ 57,096	\$ 69,908	\$ 32,690
24 x 14	\$ 67,212	\$ 72,742	\$ 33,442
24 x 16	\$ 67,255	\$ 73,857	\$ 30,017
24 x 18	\$ 83,315	\$ 93,114	\$ 31,403
24 x 20	\$ 95,319	\$ 115,715	\$ 40,233
24 x 24	\$ 95,319	\$ 121,906	

30 x 6	\$ 106,368	\$ -	\$ -
30 x 8	\$ 106,427	\$ -	\$ -
30 x 10	\$ 107,585	\$ -	\$ -
30 x 12	\$ 108,847	\$ 114,326	\$ -
30 x 14	\$ 109,438	\$ 114,728	\$ -
30 x 16	\$ 110,757	\$ 118,636	\$ 58,213
30 x 18	\$ 110,782	\$ 118,665	\$ 59,182
30 x 20	\$ 112,553	\$ 122,068	\$ 63,534
30 x 24	\$ 151,722	\$ 165,256	\$ 72,348
30 x 30	\$ 160,385	\$ 182,042	\$ NO

36 x 12	\$ 165,453	\$ 170,837	\$ -
36 x 14	\$ 165,658	\$ 170,837	\$ -
36 x 16	\$ 166,631	\$ 173,023	\$ -
36 x 18	\$ 166,971	\$ 173,791	\$ 91,898
36 x 20	\$ 168,482	\$ 177,236	\$ 93,754
36 x 24	\$ 172,012	\$ 183,117	\$ 102,502
36 x 30	\$ 220,738	\$ 240,688	\$ 118,493
36 x 36	\$ 245,591	\$ 276,325	

42 x 12	Cotizar	Cotizar	Cotizar
42 x 14	Cotizar	Cotizar	Cotizar
42 x 16	Cotizar	Cotizar	Cotizar
42 x 18	Cotizar	Cotizar	Cotizar
42 x 20	Cotizar	Cotizar	Cotizar
42 x 24	Cotizar	Cotizar	Cotizar
42 x 30	Cotizar	Cotizar	Cotizar
42 x 36	Cotizar	Cotizar	Cotizar
42 x 42	Cotizar		

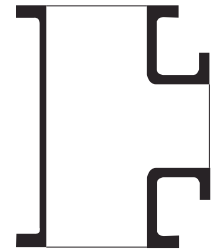

TEE

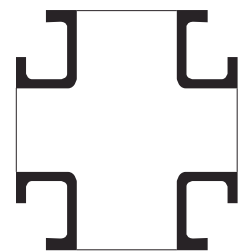

CRUZ

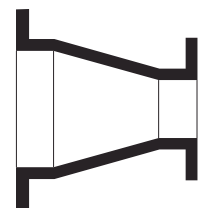

REDUCCION

### EXTREMIDADES Y CARRETES

DIMENSION	ASBESTO CEMENTO			PVC
	A5 - A7	A - 10	A - 14	
2	\$ 693	\$ 693	\$ 693	\$ 568
2 ½	\$ 926	\$ 926	\$ 926	\$ 828
3	\$ 796	\$ 796	\$ 796	\$ 796
4	\$ 1,032	\$ 1,032	\$ 1,032	\$ 1,032
6	\$ 1,567	\$ 1,567	\$ 1,666	\$ 1,567
8	\$ 2,629	\$ 2,629	\$ 3,137	\$ 2,629
10	\$ 4,256	\$ 4,256	\$ 4,487	\$ 4,094
12	\$ 5,747	\$ 5,747	\$ 5,826	\$ 5,463
14	\$ 9,341	\$ 9,341	\$ 12,227	\$ 9,341
16	\$ 13,844	\$ 13,844	\$ 13,844	\$ 13,843
18	Cotizar	Cotizar	Cotizar	\$ 16,307
20	Cotizar	Cotizar	Cotizar	Cotizar
24	\$ 28,790	\$ 28,790	\$ 28,790	\$ 27,310
30	Cotizar	Cotizar	Cotizar	Cotizar
36	Cotizar	Cotizar	Cotizar	Cotizar

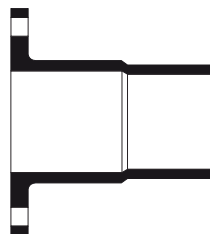

DIMENSION	LONGITUD	
	25 CMS.	50 CMS.
2	\$ 742	\$ 1,172
2 ½	\$ 1,032	\$ 1,567
3	\$ 1,363	\$ 2,092
4	\$ 1,652	\$ 2,489
6	\$ 2,425	\$ 3,690
8	\$ 3,800	\$ 5,537
10	\$ 5,202	\$ 7,803
12	\$ 7,304	\$ 8,887

### TORNILLOS

MEDIDA	PRECIO UNITARIO
7/16 x 4	\$ 13
7/16 x 4½	\$ 13

1/2 x 2½	\$ 17
1/2 x 3	\$ 17
1/2 x 3½	\$ 17
1/2 x 4	\$ 18
1/2 x 4½	\$ 18
1/2 x 5	\$ 24
1/2 x 6	\$ 24

5/8 x 2½	\$ 20
5/8 x 3	\$ 24
5/8 x 3½	\$ 39
5/8 x 5	\$ 39
5/8 x 5½	\$ 51

3/4 x 3½	\$ 39
3/4 x 4	\$ 46
3/4 x 6	\$ 70

MEDIDA	PRECIO UNITARIO
7/8 x 4	\$ 67
7/8 x 6	\$ 111

1 x 4	\$ 97
1 x 5	\$ 122
1 x 8	\$ 148

1 1/8 x 5	\$ 241
-----------	--------

1¼ x 5½	\$ 312
1¼ x 6½	\$ 344

1½ x 7	\$ 504
1½ x 7½	\$ 504
1½ x 8	\$ 516

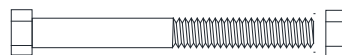

### JUNTAS GIBAULT, ABRAZADERAS, EMPAQUES, BRIDAS Y CONTRAMARCOS

#### JUNTAS GIBAULT

DIMENSION	A5 - A7	A - 10	A - 14	PVC
2	\$ 134	\$ 138	\$ 138	\$ 131
2 1/2	\$ 151	\$ 163	\$ 163	\$ 151
3	\$ 169	\$ 169	\$ 198	\$ 169
4	\$ 249	\$ 249	\$ 280	\$ 249
6	\$ 418	\$ 418	\$ 418	\$ 418
8	\$ 644	\$ 644	\$ 804	\$ 644
10	\$ 823	\$ 955	\$ 1,078	\$ 804
12	\$ 1,110	\$ 1,110	\$ 1,124	\$ 1,098
14	\$ 1,781	\$ 1,795	\$ 1,855	\$ 1,507
16	\$ 1,972	\$ 2,128	\$ 2,322	\$ 1,855
18	\$ 2,388	\$ 2,735	\$ 3,120	\$ 2,225
20	\$ 3,225	\$ 3,623	\$ 4,178	\$ 3,119
24	Cotizar	Cotizar	Cotizar	Cotizar
30	Cotizar	Cotizar	Cotizar	Cotizar
36	Cotizar	Cotizar	Cotizar	ND

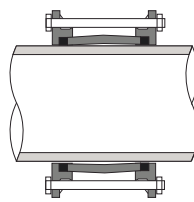

#### ABRAZADERAS

DIMENSION	AC 1/2 y 3/4"	PVC 1/2 y 3/4"
2	\$ 90	\$ 90
2 1/2	\$ 94	\$ 94
3	\$ 116	\$ 116
4	\$ 146	\$ 146
6	\$ 204	\$ 204
8	\$ 274	\$ 274
10	\$ 339	\$ 339
12	\$ 537	\$ 537

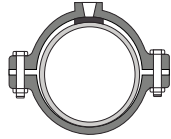

#### EMPAQUES

DIMENSION	PLOMO	NEOPRENO	GOMAS GIBAULT	
			NORMAL	REFORZADA
2	\$ 31	\$ 17	\$ 10	\$ 22
2 1/2	\$ 38	\$ 22	\$ 12	\$ 31
3	\$ 49	\$ 29	\$ 14	\$ 33
4	\$ 69	\$ 39	\$ 20	\$ 39
6	\$ 83	\$ 52	\$ 33	\$ 67
8	\$ 165	\$ 113	\$ 40	\$ 80
10	\$ 241	\$ 169	\$ 63	\$ 126
12	\$ 306	\$ 224	\$ 76	\$ 171
14	\$ 425	\$ 325	\$ 94	\$ 310
16	\$ 528	\$ 433	\$ 118	\$ 341
18	\$ 626	\$ 486	\$ 162	\$ 361
20	\$ 783	\$ 604	\$ 190	\$ 421
24	\$ 1,035	\$ 756	\$ 250	\$ 710
30	\$ 1,652	\$ 1,105	\$ 407	-
36	\$ 2,213	\$ 1,493	\$ 564	-

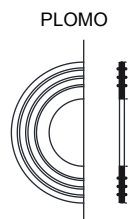

NEOPRENO

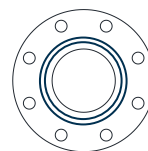

#### BRIDAS

DIMENSION	TIPO	
	C/ROSCA	SOLDABLE
2	\$ 175	\$ 178
2 1/2	\$ 272	\$ 252
3	\$ 335	\$ 291
4	\$ 442	\$ 418
6	\$ 662	\$ 568
8	\$ 1,198	\$ 945
10	\$ 2,051	\$ 1,299
12	\$ 2,606	\$ 2,065
14	\$ -	\$ 2,925
16	\$ -	\$ 3,609
18	\$ -	\$ 4,445
20	\$ -	\$ 6,167
24	\$ -	\$ 8,459
30		Cotizar
36		Cotizar

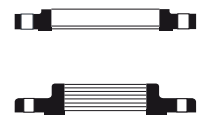

#### CONTRAMARCOS

DIMENSION	CENTRADO O DESCENT.	
	SENCILLO	DOBLE
4" x 0.90	\$ 1,173	\$ -
4" x 1.00	\$ 1,233	\$ -
4" x 1.10	\$ 1,303	\$ -
4" x 1.20	\$ 1,367	\$ -
4" x 1.30	\$ 1,435	\$ -
4" x 1.40	\$ 1,499	\$ 1,938
4" x 1.50	\$ 1,562	\$ 2,003
4" x 1.60	\$ 1,638	\$ 2,089
4" x 1.70	\$ 1,706	\$ 2,157
4" x 1.80	\$ 1,768	\$ 2,221
4" x 1.90	\$ 1,833	\$ 2,284
4" x 2.00	\$ 1,912	\$ 2,387
4" x 2.10	\$ 1,974	\$ 2,452

DIMENSION	CENTRADO O DESCENT.	
	SENCILLO	DOBLE
6" x 1.30	\$ 2,209	\$ -
6" x 1.40	\$ 2,308	\$ -
6" x 1.50	\$ 2,404	\$ 3,560
6" x 1.60	\$ 2,548	\$ 3,680
6" x 1.70	\$ 2,644	\$ 3,778
6" x 1.80	\$ 2,742	\$ 3,877
6" x 1.90	\$ 2,838	\$ 3,972
6" x 2.00	\$ 2,960	\$ 4,068
6" x 2.10	\$ 3,059	\$ 4,272
6" x 2.20	\$ 3,154	\$ 4,711
6" x 2.30	\$ 3,509	\$ 4,951
6" x 2.40	\$ 3,685	\$ 5,234

-SENCILLO CENTRADO  
-SENCILLO DESCENTRADO

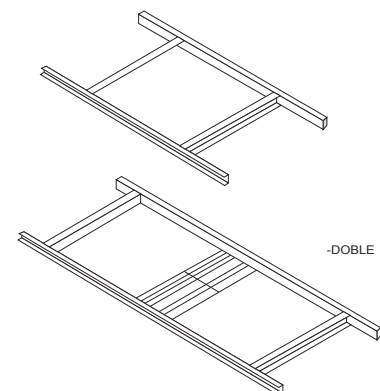

-DOBLE

### ALCANTARILLADO

DESCRIPCION	PRECIO UNITARIO
BROCAL CON REJILLA DE DUCTIL	\$ 2,688
BROCAL CON REJILLA DE 80 KG.	\$ 1,684
BROCAL CON REJILLA DE 90 KG.	\$ 1,925
BROCAL CON REJILLA DE 110 KG.	\$ 2,406
BROCAL CON REJILLA DE 130 KG.	\$ 2,887
BROCAL CON REJILLA DE 150 KG.	\$ 3,368
BROCAL CON REJILLA DE 160 KG.	\$ 3,609

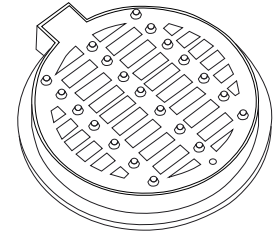

BROCAL CIEGO DE DUCTIL	\$ 2,688
BROCAL CIEGO DE 85 KG	\$ 1,804
BROCAL CIEGO DE 95 KG	\$ 2,045
BROCAL CIEGO DE 115 KG	\$ 2,526
BROCAL CIEGO DE 135 KG	\$ 3,007
BROCAL CIEGO DE 160 KG	\$ 3,609
BROCAL CIEGO DE 165 KG	\$ -

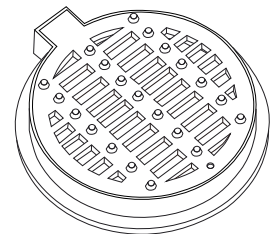

MARCO CON TAPA AP 50 X 50 CM DUCTIL	\$ 3,344
MARCO CON TAPA AP 50 X 50 CM DE 67 KG	\$ 1,492
MARCO CON TAPA AP 50 X 50 CM DE 80 KG	\$ 1,804
MARCO CON TAPA AP 50 X 50 CM DE 110 KG	\$ 2,406
MARCO CON TAPA AP 50 X 50 CM DE 130 KG	\$ 2,887

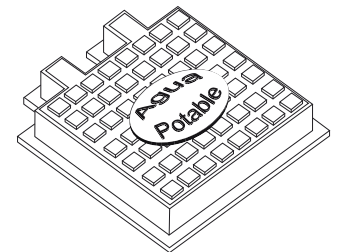

CAJA PARA LLAVE DE BANQUETA (BOTA LARGA)	\$ 183
CAJA PARA LLAVE DE BANQUETA (BOTA CORTA)	\$ 126
ESCALON PARA POZO DE VISITA LIGERO	\$ 86
ESCALON PARA POZO DE VISITA PESADO	\$ 124
COLADERA PLUVIAL	\$ 1,923
PLATO ROMPECHORRO COMPLETO	\$ 2,489
REGISTRO PARA VALVULA TELESCOPICO DE 61 A 92 CM.	\$ 1,968
REGISTRO PARA VALVULA TELESCOPICO DE 92 A 122 CM.	\$ 2,887

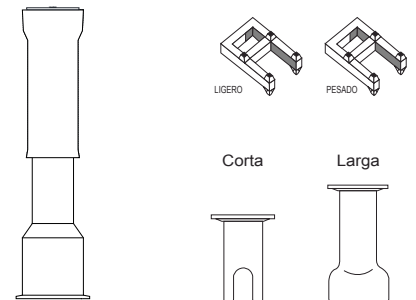

ARO Y TAPA CFE 84-B DE 105 KG	\$ 2,496
ARO Y TAPA CFE 84-B DE 120 KG	\$ 2,733
ARO Y TAPA CFE 84-B DE 135 KG	\$ 3,093
ARO Y TAPA CFE 84-B DE 110 KG CON BISAGRA	\$ 2,518
ARO Y TAPA CFE 84-B DE 125 KG CON BISAGRA	\$ 3,147
ARO Y TAPA CFE 84-B DE 140 KG CON BISAGRA	\$ 3,690

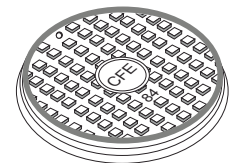

MARCO TAPA CFE 84-A DE 150 KG	\$ 4,037
MARCO TAPA CFE 84-A DE 180 KG	\$ 4,775
MARCO Y TAPA CFE 84-A DE 190 KG CON BISAGRA	\$ 5,003
MARCO Y TAPA REFORZADO CFE 84-A DE 250 KG	\$ 6,728
MARCO Y TAPA REFORZADO CFE 84-A DE 250 KG C/ BISAGRA	\$ 6,950

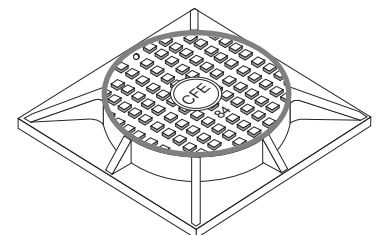

\*\*\*\*\* PRECIOS SUJETOS A CAMBIOS SIN PREVIO AVISO

### VALVULAS DE MARIPOSA SIGMA FLOW

PRECIOS DE LISTA UNITARIOS EN PESOS  
VALVULAS CON OPERADOR DE PALANCA  
VALVULAS NO INCLUYEN OPERADOR DE ENGRANES

Materiales	Valvula Mariposa	
	Hierro Gris	Hierro Gris
<b>Cuerpo</b>	H. Ductil / Rilsan	Ac. Inoxidable
<b>Disco</b>	H. Ductil / Rilsan	Ac. Inoxidable
<b>Vastago</b>	Acero C/Zinc	Ac. Inoxidable
<b>Asiento</b>	Buna	EPDM / Buna
<b>Presion</b>	150 PSI	250 PSI
<b>2"</b>	\$ 682	\$ 1,122
<b>2 1/2"</b>	\$ 756	\$ 1,146
<b>3"</b>	\$ 851	\$ 1,272
<b>4"</b>	\$ 1,006	\$ 1,748
<b>6"</b>	\$ 1,551	\$ 2,618
<b>8"</b>	\$ 2,909	\$ 5,095
<b>10"</b>	\$ 3,813	\$ 7,304
<b>12"</b>	\$ 5,297	\$ 10,654

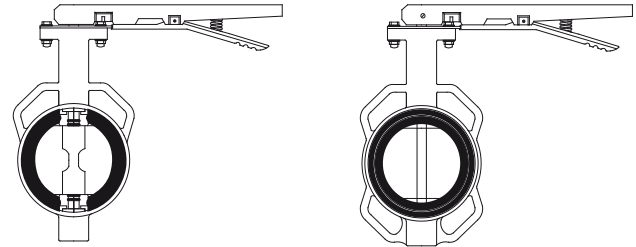

Operador de engranes	
<b>2"</b>	\$ 542
<b>2 1/2"</b>	\$ 587
<b>3"</b>	\$ 587
<b>4"</b>	\$ 587
<b>6"</b>	\$ 587
<b>8"</b>	\$ 1,039
<b>10"</b>	\$ 1,449
<b>12"</b>	\$ 1,449

### VALVULAS DE MARIPOSA MARCA BRAY

PRECIOS DE LISTA UNITARIOS EN DOLARES USA  
VALVULAS NO INCLUYEN OPERADOR DE ENGRANES

TAMAÑO VALVULA	Materiales		Tipo Oblea		Operador de Engranes
	Cuerpo	Hierro Dúctil	Hierro Dúctil		
	Disco	H. Ductil Nylon	Ac. Inoxidable		
	Vastago	Ac. Inoxidable	Ac. Inoxidable		
	Asiento	EPDM / Buna	EPDM / Buna		
TAMAÑO VALVULA	PESO (LBS)	INCLUYE OPERADOR DE PALANCA		Operador de Engranes	
<b>2"</b>	6	\$ 102	\$ 119	\$ 133	
<b>2.5"</b>	9	\$ 108	\$ 122	\$ 133	
<b>3"</b>	10	\$ 115	\$ 135	\$ 133	
<b>4"</b>	14	\$ 142	\$ 179	\$ 133	
<b>6"</b>	22	\$ 200	\$ 265	\$ 133	
<b>8"</b>	38	\$ 294	\$ 494	\$ 189	
<b>10"</b>	51	\$ 424	\$ 807	\$ 189	
<b>VASTAGO DESNUDO</b>					
<b>12"</b>	71	\$ 524	\$ 1,172	\$ 189	
<b>14"</b>	114	\$ 725	\$ 1,605	\$ 257	
<b>16"</b>	193	\$ 1,033	\$ 2,163	\$ 295	
<b>18"</b>	222	\$ 1,444	\$ 3,140	\$ 521	
<b>20"</b>	315	\$ 1,897	\$ 3,852	\$ 521	
<b>Cuerpo Bridado Inc. Op. De Engranes</b>					
<b>24"</b>	506	\$ 5,403	\$ 10,275	\$ 558	
<b>30"</b>	610	\$ 10,217	\$ 18,953	\$ 2,197	
<b>36"</b>	1185	\$ 13,957	\$ 25,998	\$ 2,308	



### VALVULAS ELIMINADORAS DE AIRE Y VALVULAS DE ADMISION Y EXPULSION DE AIRE



DIMENSION	ELIMINADORAS	ADM. Y EXP DE AIRE	COMBINADAS
	200 PSI	200 PSI	200 PSI
1/2"	\$ 823	\$ 996	\$ 1,760
3/4"	\$ 823	\$ 996	\$ 1,760
1"	\$ 823	\$ 996	\$ 1,760
2"	\$ 1,666	\$ 1,741	\$ 2,721
3"		\$ 2,826	\$ 3,752
4"		\$ 5,352	\$ 6,108
6"		\$ 7,832	\$ 8,992
8"		Cotizar	Cotizar
10"		Cotizar	Cotizar

### VALVULAS AUTOMATICAS

#### CAMARA SENCILLA (Precios en Dolares USA)

DIMENSION	REDUCT. DE PRESION	FLOTADOR	ALIVIO Y CTRA GPE ARIETE
	250 lbs	250 lbs	250 lbs
2"	\$ 961	\$ 958	\$ 653
2 1/2"	\$ 983	\$ 987	\$ 684
3"	\$ 1,143	\$ 1,158	\$ 1,011
4"	\$ 1,447	\$ 1,600	\$ 1,359
6"	\$ 2,524	\$ 2,511	\$ 2,727
8"	\$ 3,479	\$ 3,528	\$ 3,685
10"	\$ 5,135	\$ 5,017	\$ 5,811
12"	\$ 10,284	\$ 10,568	\$ 10,693



#### CAMARA DOBLE, CUERPO EN "Y" (Precios en Dolares USA)

DIMENSION	REDUCT. DE PRESION	FLOTADOR	ALIVIO Y CTRA GPE ARIETE
	250 lbs	250 lbs	250 lbs
2"	\$ 1,412	\$ 1,296	\$ 979
2 1/2"	\$ 1,457	\$ 1,406	\$ 1,023
3"	\$ 1,639	\$ 1,615	\$ 1,380
4"	\$ 2,177	\$ 2,220	\$ 2,305
6"	\$ 3,684	\$ 3,464	\$ 3,789
8"	\$ 5,180	\$ 5,009	\$ 5,211
10"	\$ 7,989	\$ 7,921	\$ 8,506
12"	\$ 11,370	\$ 11,464	\$ 11,378



### ADAPTADOR BRIDADO UNIVERSAL Y COPLER UNIVERSAL DE RANGO AMPLIO

DIMENSION	RANGO	PRECIO UNITARIO
2"	48-60	\$ 450
	59-72	\$ 474
2 1/2"	72-85	\$ 485
3"	88-103	\$ 737
4"	96-116	\$ 816
	109-130	\$ 816
6"	159-184	\$ 1,164
8"	192-210	\$ 1,768
	218-235	\$ 1,768
10"	250-267	\$ 2,170
	250-274	\$ 2,170
	272-289	\$ 2,170
12"	315-332	\$ 2,683
	322-342	\$ 3,494
	324-365	\$ 3,494
14"	351-378	\$ 4,929
16"	390-410	\$ 5,805
	425-442	\$ 6,298
18"	436-463	\$ 9,858
	476-500	\$ 10,406
20"	500-508	\$ 11,501
	526-546	\$ 12,323
24"	608-636	\$ 14,787

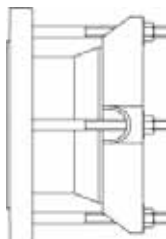

DIMENSION	RANGO	PRECIO UNITARIO
2"	48-60	\$ 386
	59-72	\$ 462
2 1/2"	72-85	\$ 509
3" - 4"	88-103	\$ 768
	96-116	\$ 836
4"	109-130	\$ 868
	118-135	\$ 868
6"	159-184	\$ 1,226
	173-193	\$ 1,226
8"	192-210	\$ 1,995
	218-235	\$ 1,995
8" - 10"	225-250	\$ 2,135
10"	242-262	\$ 2,307
	250-267	\$ 2,451
	272-289	\$ 2,524
10" - 12"	281-309	\$ 2,679
12"	315-332	\$ 2,912
	322-342	\$ 2,979
12"	332-354	\$ 3,315
14"	351-378	\$ 3,502
14" - 16"	390-410	\$ 5,574
16"	425-442	\$ 5,866
18"	454-463	\$ 6,803
18" - 20"	476-500	\$ 6,803
20"	500-508	\$ 7,270
	526-546	\$ 7,441
24"	608-636	\$ 8,403

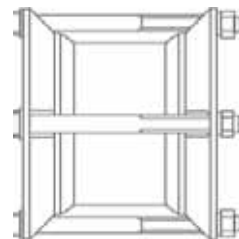

### ALCANTARILLADO POLIETILENO

DESCRIPCION	PRECIO UNITARIO
BROCAL CIEGO POLIETILENO MEDIA DENSIDAD	\$ 1,469
BROCAL CON REJILLA POLIETILENO MEDIA DENSIDAD	\$ 1,469
BROCAL CIEGO POLIETILENO HALO EXTENDIDO	\$ 2,308
MARCO CON TAPA AP 50 X 50 CM POLIETILENO	\$ 1,417

### LISTA DE PRECIOS ABRAZADERAS DE REPARACION DE ACERO INOXIDABLE

DIAMETRO	LARGO	RANGO EN MM	PRECIO UNITARIO
2	8	59-67	\$ 895
2.5	8	69-76	\$ 997
3	8	88-94	\$ 1,015
	8	95-105	\$ 1,015
4	8	113-123	\$ 1,217
	8	120-131	\$ 1,217
	8	132-142	\$ 1,217
6	8	155-175	\$ 1,503
	8	166-177	\$ 1,503
	8	170-190	\$ 1,503
	8	173-194	\$ 1,503
	8	179-189	\$ 1,503
8	8	205-225	\$ 1,804
	8	218-228	\$ 1,804
	8	235-246	\$ 1,804

DIAMETRO	LARGO	RANGO EN MM	PRECIO UNITARIO
10	8	246-257	\$ 2,361
	8	271-282	\$ 2,361
	12	280-290	\$ 3,399
	12	280-291	\$ 3,399
	12	288-298	\$ 3,399
12	12	322-332	\$ 3,949
	12	334-364	\$ 3,949
14	12	345-355	\$ 4,483
16	12	388-419	\$ 5,572
18	12	434-465	\$ 6,664
20	12	495-525	\$ 7,133
	24	495-525	\$ 11,689
24	24	590-621	\$ 13,712

### CARRETES DE DESMONTAJE

DIMENSION	PRECIO UNITARIO
4"	\$ 2,593
6"	\$ 3,827
8"	\$ 5,085
10"	\$ 7,101
12"	\$ 11,564

### FILTROS "Y"

DIMENSION	PRECIO UNITARIO
2"	\$ 1,058
2 1/2"	\$ 1,379
3"	\$ 1,783
4"	\$ 2,507
6"	\$ 5,262
8"	\$ 10,109
10"	\$ 17,707
12"	\$ 20,767

### JUNTAS TIPO DRESER

DISPONIBLES DE 2" A 48"  
COTIZAR DE ACUERDO A DIAMETRO EXTERIOR DE TUBERIA

### TUBERIA DE ACERO GALVANIZADO

DISPONIBLES EN GRADO A Y GRADO B  
LONGITUD DE 6.4 MTS